

Part Number: PT922-47100

Kit Contents

| Item # | Quantity Req'd. | Description |
|--------|-----------------|-----------------------------|
| 1 | 1 | Door Sill, Front Right Hand |
| 2 | 1 | Door Sill, Front Left Hand |
| 3 | 1 | Door Sill, Rear Right Hand |
| 4 | 1 | Door Sill, Rear Left Hand |
| 5 | 1 | Hardware Kit |

Hardware Bag Contents

| Item # | Quantity Req'd. | Description |
|--------|-----------------|-----------------------|
| 1 | 4 | T-Taps |
| 2 | 10 | Tie Straps |
| 3 | 4 | Tape, Foam 25 x 25 mm |
| 4 | 2 | Tape, Foam 50 x 60 mm |

Additional Items Required For Installation

| Item # | Quantity Req'd. | Description |
|--------|-----------------|-------------|
| 1 | N/A | |
| 2 | | |
| 3 | | |

Conflicts

| |
|------|
| None |
|------|

Recommended Tools

| Personal & Vehicle Protection | Notes |
|--|-------------------------|
| Safety Glasses | |
| Safety Gloves | Optional |
| Vehicle Protection | Blankets, Part Boxes |
| | |
| Special Tools | Notes |
| Nylon Panel Removal Tool | |
| | |
| Installation Tools | Notes |
| Wrench | 10mm |
| Pliers | For T-Taps |
| Side Cutters | For Wire Ties |
| Torque Wrench | 48 lbf-in |
| Wiping cloth | For cleaning pinch weld |
| | |
| Special Chemicals | Notes |
| VDC Approved cleaner | |

NOTE: Part number of this accessory may not be the same as the part number shown.

General Applicability

| |
|---------------|
| Prius Plug-in |
|---------------|

Recommended Sequence of Application







| Item # | Accessory |
|--------|------------------------|
| 1 | Illuminated door sills |
| 2 | Security |
| 3 | Remote Engine Start |
| | |

***Mandatory**

Vehicle Service Parts (may be required for reassembly)

| Item # | Quantity Req'd. | Description |
|--------|-----------------|-------------|
| 1 | N/A | |
| 2 | | |
| 3 | | |

Legend

| | |
|---|--|
|  | STOP: Damage to the vehicle may occur. Do not proceed until process has been complied with. |
|  | OPERATOR SAFETY: Use caution to avoid risk of injury. |
|  | CAUTION: A process that must be carefully observed in order to reduce the risk of damage to the accessory/vehicle and to ensure a quality installation. |
|  | TOOLS & EQUIPMENT: Used in Figures calls out the specific tools and equipment recommended for this process. |
|  | REVISION MARK: This mark highlights a change in installation with respect to previous issue. |
|  | SAFETY TORQUE: This mark indicates that torque is related to safety. |

Care must be taken when installing this accessory to ensure damage does not occur to the vehicle. The installation of this accessory should follow approved guidelines to ensure a quality installation.

These guidelines can be found in the "Accessory Installation Practices" document.

This document covers such items as:-

- Vehicle Protection (use of covers and blankets, cleaning chemicals, etc.).
- Safety (eye protection, rechecking torque procedure, etc.).
- Vehicle Disassembly/Reassembly (panel removal, part storage, etc.).
- Electrical Component Disassembly/Reassembly (battery disconnection, connector removal, etc.).

Please see your Toyota dealer for a copy of this document.

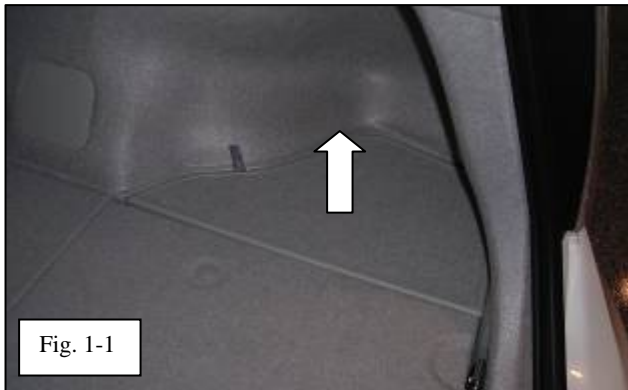

1. Preparation.

(a) Inspect all kit components and check for damage or missing parts.

(b) Remove the negative battery cable.

(1) Remove the right rear floor board top panel. (Fig. 1-1)

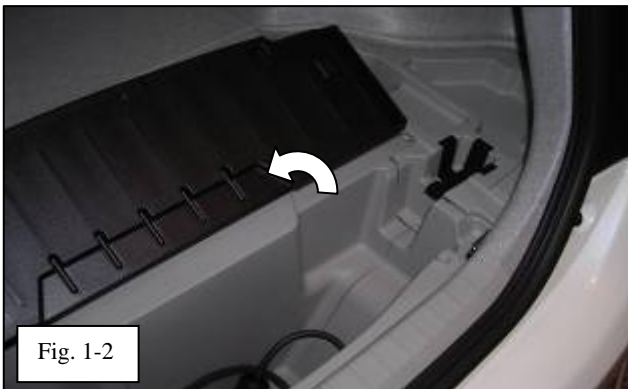

(2) Open the rear floor board flap. (Fig. 1-1)

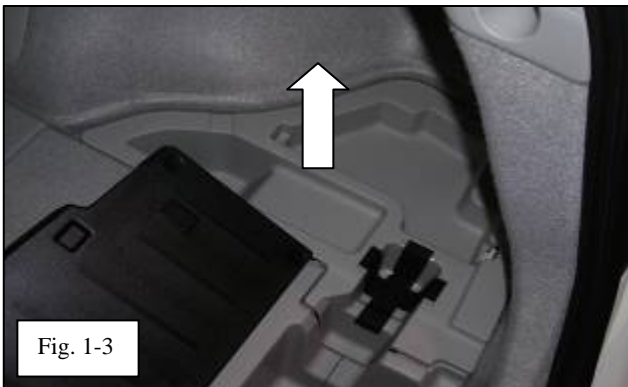

(3) Remove the right rear floor board panel. (Fig. 1-3)

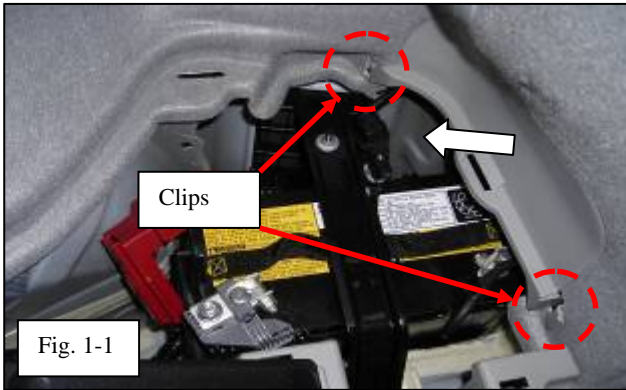

- (4) Remove the right rear trim panel. (Fig 1-4)

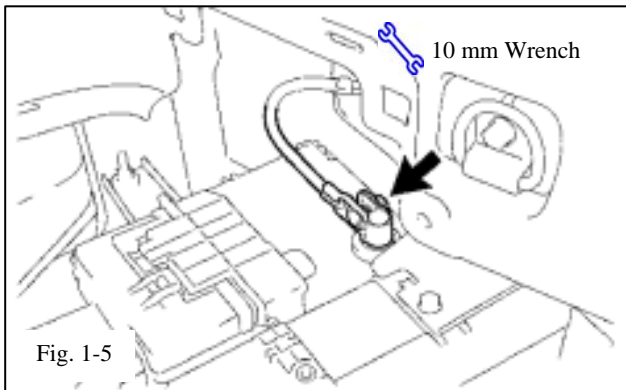

- (5) Remove the negative battery cable using a 10mm wrench. (Fig. 1-5)



- (1) Do not touch the positive terminal with any tool part of the tool when removing cable.

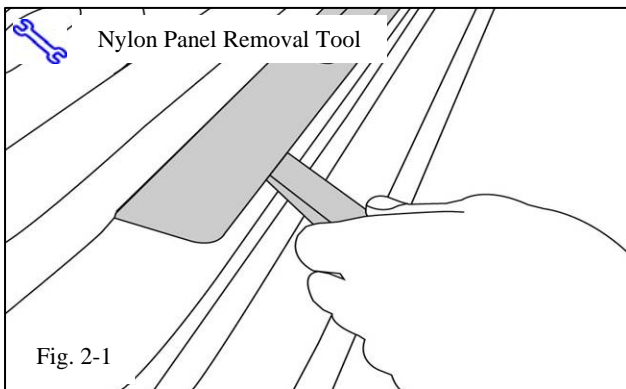

2. Vehicle disassembly.

- (a) Remove the front left and front right outer door sill plates using a nylon panel removal tool. (Fig. 2-1)
 - (1) Apply tape to the body surface to prevent scratches.

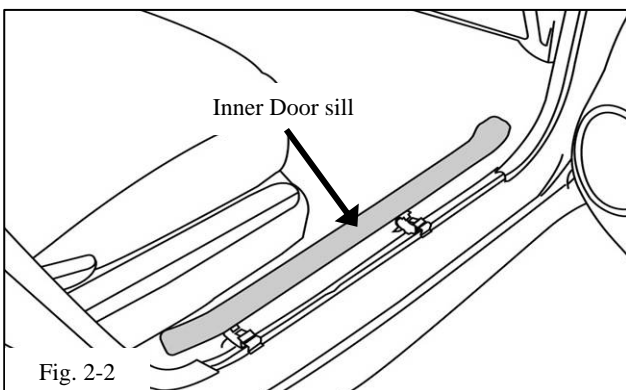

- (b) Remove the front left and front right inner door sill panels. (Fig. 2-2)

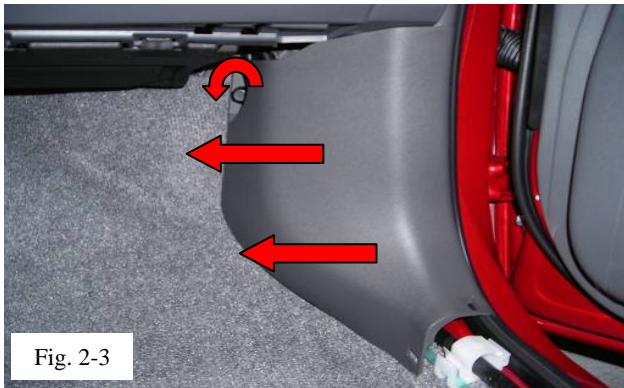

- (c) Remove the front left and front right cowl side covers. (Fig. 2-3)
 - (1) Remove the retaining nut.
 - (2) Pull the cover straight away from the body to detach the two clips.
 - (3) If a clip is stuck to the body after removal, remove the clip and reattach it to the cowl cover.

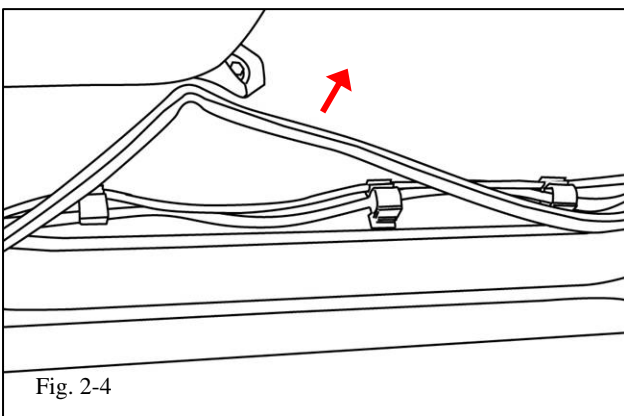

- (d) Detach the front left and right weather seal from the pinch weld. (Fig. 2-4)



- (e) Remove the rear left and rear right outer door sill plates. (Fig 2-5)
 - (1) Apply tape to the body surface to prevent scratches.

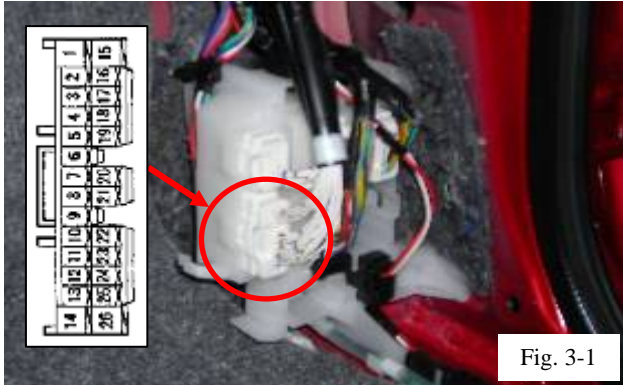

Fig. 3-1

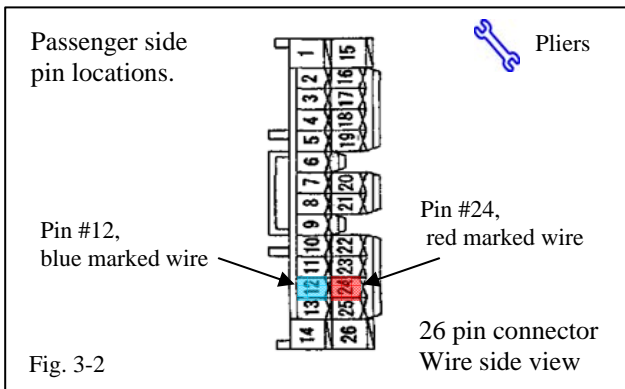

Fig. 3-2

3. Install Passenger side T-taps.

(a) Locate the 26 pin connector on the passenger side cowl area. (Fig. 3-1)

(b) Locate the white wire with a **BLUE** mark, pin 12 on the 26 pin connector. (Fig. 3-2)

(1) Install a t-tap about 1 inch from the connector end.



(2) Make sure t-tap is snapped in correctly.

(c) Locate the white wire with a **RED** mark, pin 24 on the 26 pin connector. (Fig. 3-2)

(1) Install a t-tap about 1.5 inches from the connector end.



(2) Make sure t-tap is snapped in correctly.

4. Install front passenger door sill plate.

(a) Locate the front Right Hand (RH) door sill plate.



(1) When installing the door sill to the correct side, the word “PRIUS” is located closest to the rear of the vehicle.

(Fig. 4-1)



Fig 4-1

(b) Align the 3 clips of the door sill to the holes of the body rocker panel. Gently push the door sill plate down to insert the clips. (Fig 4-2)



(1) Make sure door sill is properly snapped down in place and that there is no lifting or uneven gaps around the edges.



Fig 4-2



- (c) Clean the pinch weld surface behind the door sill harness with a wiping cloth and a VDC approved cleaner. (Fig. 4-3)



- (d) Place one SMALL foam tape (25 x 25 mm) over the pinch weld where the wire harness exits the door sill plate. (Fig 4-4)



- (1) Make sure the tape is placed in the area on the pinch weld where the flexible portion of the weather seal is installed.



- (e) Route the harness over the foam tape and secure it with a second piece of SMALL foam tape (25 x 25 mm) over the first piece. (Fig. 4-5)

- (f) Reinstall the weather seal to the pinch weld.

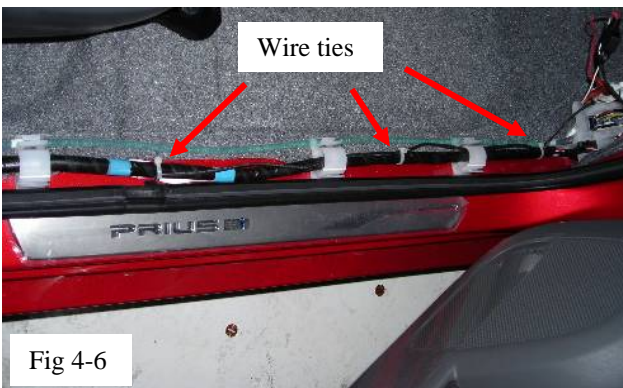

- (g) Route the door sill harness under the weather seal and to the cowl side area through the OE harness clips and secure it with three (3) tie straps. (Fig 4-6)



- (1) DO NOT secure harness to the washer fluid hose.

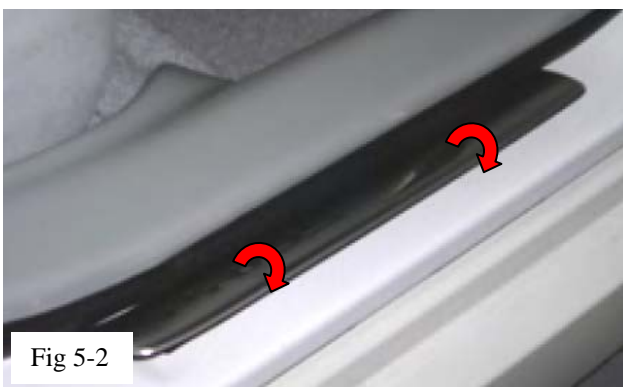
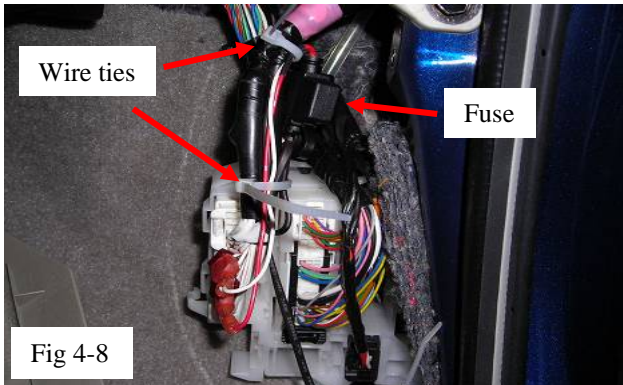

(h) Connect the **PASSENGER** side door sill harness to the t-taps.

(1) **BLUE** wire to white wire with **BLUE** mark on the 26 pin connector.

(2) **RED** wire to the white wire with **RED** mark on the 26 pin connector.



(3) Make sure spade terminal is correctly connected to the T-taps. Fig 4-7

(i) Secure the harness with (1) one tie strap above the fuse holder and (1) one below the fuse holder. (Fig 4-8)

(1) Place the fuse holder between the OE harnesses and the body with the cover accessible for fuse replacement facing the rear of the vehicle.



(2) Make sure fuse or harness placement does not obstruct any mounting holes.

5. Install rear passenger door sill plates.

(a) Locate the Right Hand (RH) door sill plate.



(1) When installing the door sill to the correct side, the word "PRIUS" is located closest to the rear of the vehicle.

(b) Place long edge of door sill plate under weather seal and align clips with insertion holes in body panel. (Fig. 5-1)

(c) Gently rotate the door sill plate down to insert the clips. (Fig. 5-2)



(1) Make sure door sill is properly snapped down in place and that there is no lifting or uneven gaps around the edges.

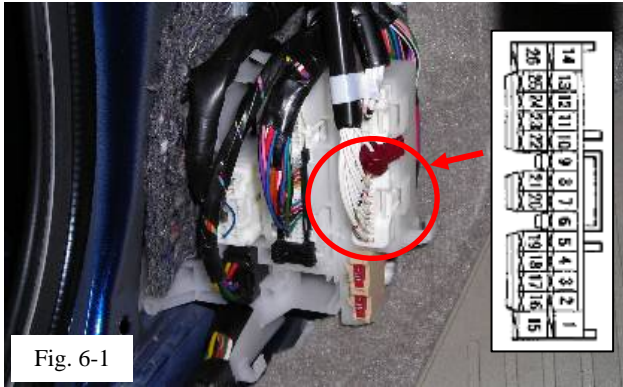

Fig. 6-1

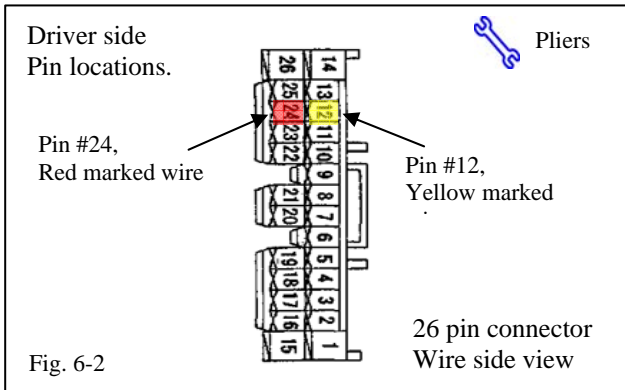

Fig. 6-2

6. Install Driver side T-taps.

(a) Locate the 26 pin connector on the driver side cowl area. (Fig. 6-1)

(b) Locate the white wire with a **YELLOW** mark, pin 12 on the 26 pin connector. (Fig. 6-2)

(1) Install a t-tap about 1 inch from the connector end.



(2) Make sure t-tap is snapped in correctly.

(c) Locate the white wire with a **RED** mark, pin 24 on the 26 pin connector. (Fig. 6-2)

(1) Install a t-tap about 1.5 inches from the connector end.



(2) Make sure t-tap is snapped in correctly.



Fig. 7-1

7. Install front driver side door sill plate.

(a) Locate the front Left Hand (LH) door sill plate.



(1) When installing the door sill to the correct side, the word “PRIUS” is located closest to the rear of the vehicle. (Fig 7-1)



Fig. 7-2

(b) Align the 3 clips of the door sill to the holes of the body rocker panel. Gently push the door sill plate down to insert the clips. (Fig 7-2)



(1) Make sure door sill is properly snapped down in place and that there is no lifting or uneven gaps around the edges.



(c) Clean the pinch weld surface behind the door sill harness with a wiping cloth and a VDC approved cleaner. (Fig. 7-3)



(d) Place one SMALL foam tape (25 x 25 mm) over the pinch weld where the wire harness exits the door sill plate. (Fig 7-4)



(1) Make sure the tape is placed in the area on the pinch weld where the flexible portion of the weather seal is installed.



(e) Route the harness over the foam tape and secure it with a second piece of SMALL foam tape (25 x 25 mm) over the first piece. (Fig. 7-5)

(f) Reinstall the weather seal to the pinch weld.

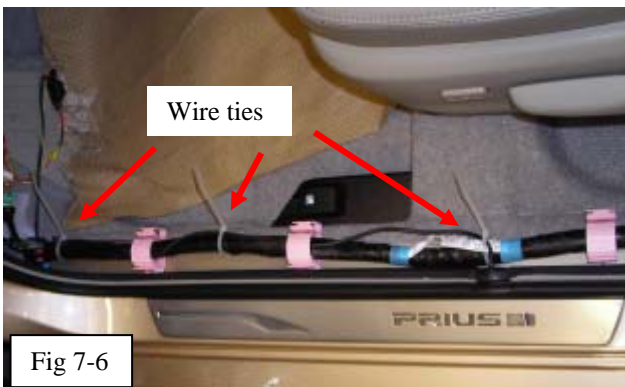

(g) Route the door sill harness to the cowl side area through the OE harness clips and secure it with three (3) tie straps. (Fig 7-6)



Fig 8-1

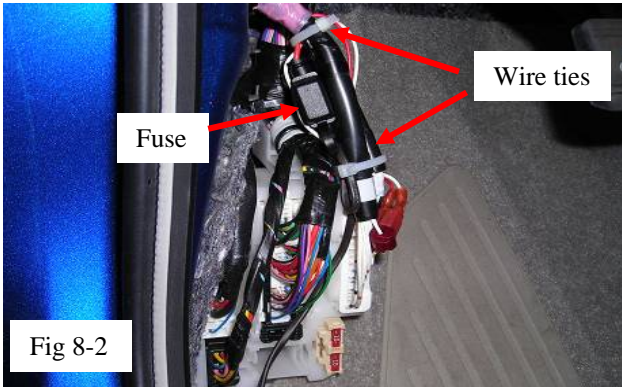



Fig 8-2

- (h) Connect the **DRIVER** side door sill harness to the t-taps. (Fig 8-1)
- (1) **YELLOW** wire to white wire with **YELLOW** mark on the 26 pin connector.
 - (2) **RED** wire to the white wire with **RED** mark on the 26 pin connector.
-  (3) Make sure spade terminal is correctly connected to the T-taps.

- (i) Secure the harness with (1) one tie strap above the fuse holder and (1) one below the fuse holder. (Fig 8-2)
- (1) Place the fuse holder between the OE harnesses and the body with the cover accessible for fuse replacement facing the rear of the vehicle.
 - (2) **If Security or RES is installed to the vehicle, wrap the fuse holder with (1) one piece of large foam tape and secure to an existing harness with (2) wire ties.**
-  (3) Make sure fuse or harness placement does not obstruct any mounting holes.

8. Install rear driver side door sill plate.

- (a) Installation of rear driver side door sill plate is similar to rear passenger side door sill plate. (See step 5)

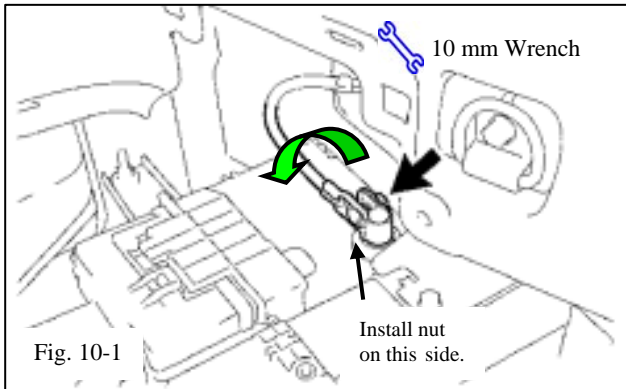
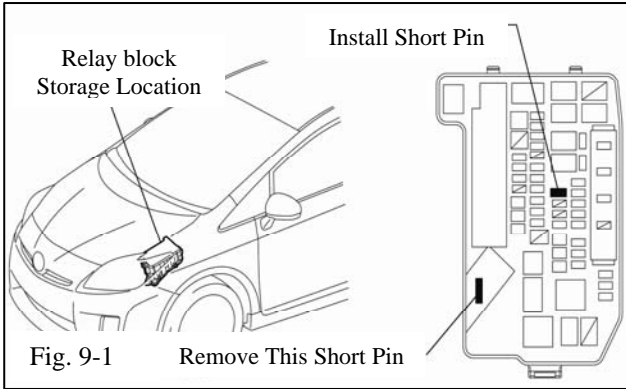

9. Testing

- (a) Temporarily reconnect the negative battery terminal.
- (b) If necessary, install the short pin located in the engine compartment. (Fig. 9-1)
- (c) Press in the front door courtesy switches to check the function of the front door sills.
 - (1) Door sill light should be on with the door open.
 - (2) Door sill light should turn off when the corresponding door courtesy switch is pressed in.

10. Vehicle reassembly.

- (a) Remove and reverse the direction of the bolt and nut from the negative battery terminal so that the nut can be accessed with a torque wrench. (Fig. 10-1)
- (b) Tighten the negative battery cable.
 - (1) Position the negative battery cable at the original factory position.
 - (2) Tighten the nut with 5.4 N-m (48 lbf-in) of torque.
- +** (3) Do not touch the positive battery terminal with any tool when replacing the cable.
- (c) Reinstall the rear trim panel, rear floor board panel, rear floor box, and rear floor board.
- (d) Trim all wire ties using a pair of wire cutters.
- (e) Reinstall both front cowl side covers.
- (f) Reinstall both front inner door sill panels.

11. Completing the installation.

- (a) Perform any accessory or vehicle function checks.
- (b) If required, replace the short pin to its original position.
- (c) Clean up and remove any trash.

TOYOTA PRIUS PLUG-IN 2012 - ILLUMINATED DOOR SILL
Checklist - these points **MUST** be checked to ensure a quality installation.

| <u>Check:</u> | <u>Look For:</u> |
|---|---|
| <p><u>Accessory Function Checks</u></p> <ul style="list-style-type: none"><input type="checkbox"/> Door sill fitment<input type="checkbox"/> Open front door<input type="checkbox"/> Press front courtesy switch | <p>There should be no uneven gaps around the edges, and clips should be securely fastened.</p> <p>Front door sill light should turn on.</p> <p>Front door sill light should turn off.</p> |
| <p><u>Vehicle Function Checks</u></p> <ul style="list-style-type: none"><input type="checkbox"/> Door courtesy lights<input type="checkbox"/> Power door locks<input type="checkbox"/> Power windows<input type="checkbox"/> Remote outside mirrors<input type="checkbox"/> Smart key functions | <p>Front door courtesy lights should operate normally.</p> <p>Power door locks should function normally.</p> <p>Front power windows should function normally.</p> <p>Remote outside mirrors should function normally.</p> <p>Smart key functions should operate normally.</p> |